



## INSTALLATION AND OPERATION MANUAL

# HS<sub>v2</sub> SERIES

*MIXER AMPLIFIER*

HS120v2 / HS250v2



# IMPORTANT SAFETY INFORMATION



1. READ these instructions.
2. Keep these instructions.
3. Heed all warnings.
4. Follow all instructions.
5. Do not use this apparatus near water.
6. Clean only with dry cloth.
7. Do not block any ventilation openings. Install in accordance with the manufacturer's instructions.
8. Do not install near any heat sources such as radiators, heat registers, stoves, or other apparatus (including amplifiers) that produce heat.
9. Do not defeat the safety purpose of the polarized or grounding-type plug. A polarized plug has two blades with one wider than the other. A grounding type plug has two blades and a third grounding prong. The wide blade or the third prong are provided for your safety. If the provided plug does not fit into your outlet, consult an electrician for replacement of the obsolete outlet.
10. Protect the power cord from being walked on or pinched particularly at plugs, convenience receptacles, and the point where they exit from the apparatus.
11. Only use attachments/accessories specified by the manufacturer.
12. Use only with the cart, stand, tripod, bracket, or table specified by the manufacturer, or sold with the apparatus. When a cart is used, use caution when moving the cart/apparatus combination to avoid injury from tip-over.
13. Unplug this apparatus during lightning storms or when unused for long periods of time.
14. Refer all servicing to qualified service personnel. Servicing is required when the apparatus has been damaged in any way, such as power-supply cord or plug is damaged, liquid has been spilled or objects have fallen into the apparatus, the apparatus has been exposed to rain or moisture, does not operate normally, or has been dropped.
15. This appliance shall not be exposed to dripping or splashing water and that no object filled with liquid such as vases shall be placed on the apparatus.
16. Plug this apparatus to the proper wall outlet and make the plug to be disconnected readily operable.
17. Mains plug is used as disconnected device and it should remain readily operable during intended use. In order to disconnect the apparatus from the mains completely, the mains plug should be disconnected from the mains socket outlet completely.
18. **WARNING:** To reduce the risk of fire or electric shock, do not expose this apparatus to rain or moisture.
19. An appliance with a protective earth terminal should be connected to a mains outlet with a protective earth connection.
20. The apparatus should be disconnected from the mains completely before speaker wiring. The speaker output should be proper protected from direct contact and pay attention to speaker connections, terminals and speaker wiring during normal operation.

# PRÉCAUTIONS DURANT UTILISATION

1. LISEZ ces instructions.
2. Tenez ces instructions.
3. Notez tous les avertissements.
4. Suivez toutes les avertissements.
5. N'utilisez pas ce produit près de l'eau (la piscine, la plage, le lac, etc.).
6. Nettoyez seulement avec une étoffe sèche.
7. Ne bloquez aucuns trous de ventilation. Installez en accord avec les instructions du manufacturier.
8. N'installez près aucunes sources de chaleur comme radiateurs, registres de chaleur, fours ou les autres équipements (y compris amplificateurs) qui produisent la chaleur.
9. Ne défaites pas le but de sécurité de la fiche polarisée ou base-type. Une fiche polarisée a deux tranchants avec un plus large que l'autre. Une fiche de base type a deux a deux tranchants et une troisième pointe de base, le tranchant large ou la troisième pointe est fourni pour votre sécurité. Si la fiche donnée ne conforme pas votre prise de contact, consultez un électricien pour remplacement de la prise de contact obsolète.
10. Protégez le cordon de secteur contre être marchée dessus ou pincé en particulier aux fiches, aux douilles de convenance, et au point où ils sortent de l'appareil.
11. Seulement utilisez attachements/accessoires spécifiés par le manufacturier.
12. Utilisez seulement avec un chariot, un stand, un trépied, un support ou une table indiquée par le manufacturier, ou vendue avec l'appareil. Quand un chariot est utilisé, faites attention en déplaçant la combinaison d'appareil/chariot pour éviter de se déséquilibrer.
13. Arrachez la fiche du dispositif durant éclair et orage ou quand pas utilisé pour longues périodes de temps.
14. Référez au personnel qualifié de service pour toutes réparations. La réparation est donnée quand le système a été endommagé à n'importe façon, par exemple un fil ou une fiche endommagé(e) de la source d'alimentation. Avoir été exposé à pluie ou humidité, n'opère pas normalement, ou avoir été tombé.
15. L'appareil ne doit pas être exposé aux écoulements ou aux éclaboussures et aucun objet ne contenant de liquide, tel qu'un vase, ne doit être placé sur l'objet.
16. Branchez l'appareil à une source appropriée et faire que la prise à débrancher soit facilement accessible.
17. La prise du secteur ne doit pas être obstruée ou doit être facilement accessible pendant son utilisation. Pour être complètement déconnecté de l'alimentation d'entrée, la prise doit être débranchée du secteur.
18. **AVERTISSEMENT:** Pour éviter le risque d'incendie ou de chocs électriques, ne pas exposer cet appareil à la pluie ou à l'humidité.
19. Un appareil avec la borne de terre de protection doit être connecté au secteur avec la connexion de terre de protection.
20. Assurez-vous que l'appareil est hors tension avant de connecter les hauts parleurs. Vérifiez que la sortie des enceintes soit protégées contre un contact physique. Respecter les polarités des terminaux ainsi que le câblage des enceintes pendant le fonctionnement afin d'assurer une utilisation sécurisée.

# INTRODUCTION & CONTENTS

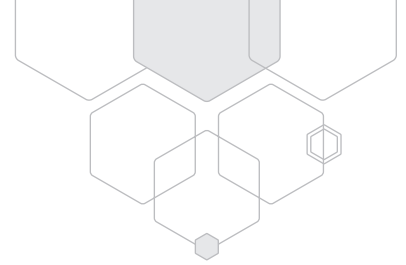

## HS<sub>v2</sub> SERIES

Congratulations on choosing Australian Monitor for your professional amplification requirements.

The design of our HS<sub>v2</sub> series mixer amplifier embraces all the aspects of a well-designed amplifier. The visual design, mechanical, electrical and sonic parameters, along with our dedicated manufacturing process, have all been optimised to provide a professional tool that exhibits quality, reliability and longevity.

The HS<sub>v2</sub> series mixer amplifiers are 1 unit 1.75" high, 19" wide, rack mountable units.

Each of the six input channels comprises a balanced and unbalanced active input, gain adjustment and equaliser. The mixer section features VCA control, gain adjustment and 3 band equaliser which feeds an efficient Class D amplifier. Additionally, the mixer amplifier includes an embedded tone generator, music player and Bluetooth® audio streaming for a complete mixer amplifier solution.

These amplifiers have been specifically designed to deliver their high power output with minimal distortion, and provide the critical degree of control required by your speakers.

Introduction	3
Features & Protection Features	4
Controls, Connectors and Indicators	5
Block diagram	8
Installation	9
Basic Setup and Operation	12
Tone Generator	14
Priority Control	17
Music Player	18
Bluetooth Audio Streaming	19
Miscellaneous	21
Fault Finding	25
Specifications	27

Revision 2.2: June 2024

## WARNING

TO PREVENT FIRE OR SHOCK HAZARD, DO NOT USE THE PLUG WITH AN EXTENSION CORD, RECEPTACLE OR OTHER OUTLET UNLESS THE BLADES CAN BE FULLY INSERTED TO PREVENT BLADE EXPOSURE.

TO REDUCE THE RISK OF FIRE OR ELECTRIC SHOCK, DO NOT EXPOSE THIS APPLIANCE TO RAIN OR MOISTURE.

TO PREVENT ELECTRICAL SHOCK, MATCH WIDE BLADE PLUG TO WIDE SLOT & FULLY INSERT.

## CAUTION

TO REDUCE THE RISK OF ELECTRIC SHOCK DO NOT PERFORM ANY SERVICING OTHER THAN THAT CONTAINED IN THE OPERATING INSTRUCTIONS UNLESS YOU ARE QUALIFIED TO DO SO.



The lightning flash with arrowhead symbol, within an equilateral triangle, is intended to alert the user to the presence of uninsulated "dangerous voltage" within the product's enclosure that may be of sufficient magnitude to constitute a risk of electric shock to persons.



### WARNING

TO REDUCE THE RISK OF ELECTRIC SHOCK, DO NOT REMOVE COVER (OR BACK). NO USER SERVICEABLE PARTS INSIDE. REFER SERVICING TO QUALIFIED SERVICE PERSONNEL.



The exclamation point within an equilateral triangle is intended to alert the user to the presence of important operating and maintenance (servicing) instructions in the literature accompanying the appliance.



For European Union countries: This symbol on the product or its packaging indicates that this product must not be disposed of with other waste. Instead, it is your responsibility to dispose of your waste equipment by handing it over to a designated collection point for the recycling of waste electrical and electronic equipment. Please contact your local authority for further details of your nearest designated collection point.

Rating plate and caution marking are marked on the back enclosure of the apparatus

# FEATURES & PROTECTION FEATURES

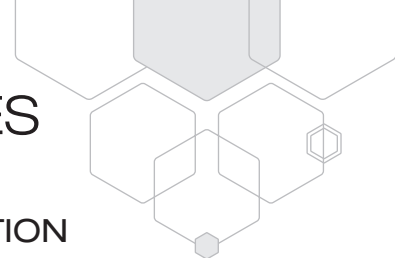

## FEATURES

- Class-D amplification
- 4Ω/70V/100V Operation
- 6 Balanced XLR inputs or unbalanced RCA inputs
- 3.5mm front line input socket
- Bluetooth® 5.1 Audio Receiver
  - Programmable Name and PIN
  - Advanced connection option
  - Phone call support (HFP Profile)
- Embedded tone generator and music player with SD card support
- Priority muting control on Channels 1-3 with level and time release control
- USB charging support for mobile devices
- 12V phantom power on balanced inputs
- Line and Record outputs
- Voltage Controlled Attenuation (VCA)
- Status, Protect and Signal LED indicators
- Power factor corrected universal switch mode power supply (HS250)
- Magnetic cover for customer concealed eq and gain controls
- Defeatable volume controls to prevent end user tampering
- 1RU height with front rack mount ears

## PROTECTION

- Clip protection
- Short-circuit protection
- Overload protection
- Thermal protection

## GLOSSARY

TERM	MEANING
TONE	Typically an alarm or alert which bypasses the pre-amplifier master control stage
MUSIC	Audio MP3 or WAV music files which are not used as 'Tones'
MP3	Lossy data compression audio coding format
WAV	Waveform audio file format
XLR	Audio electrical connector type
RCA	Audio electrical connector type
SD CARD	Secure Digital memory card
LED	Light Emitting Diode.
VOX	Voice operated output
FAT32	32 bit File Allocation Table Format. (This format should be used on the SD card)
PHOENIX CONNECTOR	Terminal block connector type. Also known as a Euroblock.
VCA	Voltage Controlled Attenuation
PHANTOM POWER	Power outputted on the XLR connector to power microphones
DIP SWITCH	Dual in-line package switch. Used on the front and rear of the product to select various settings

# CONTROLS, CONNECTORS & INDICATORS

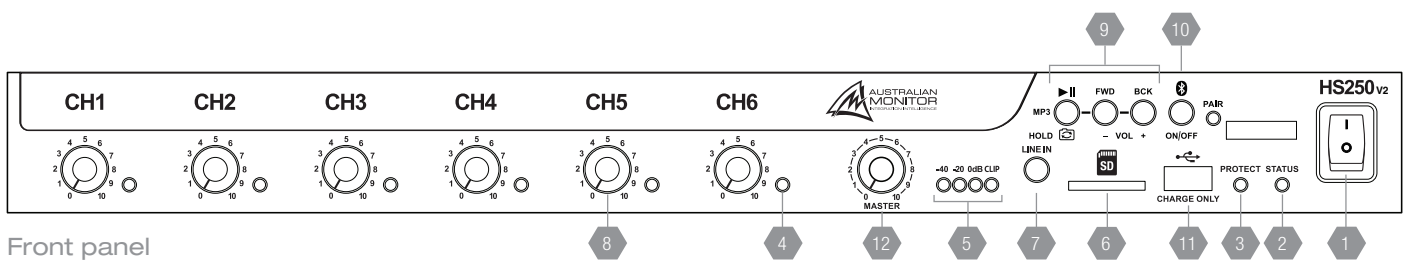

Front panel

## FRONT PANEL

The functions of the controls and indicators are as follows:

### 1 POWER SWITCH

Press the switch to up for power on and down for power off. At start-up (turn-on), the input to the amplifier is muted for approximately five seconds.

### 2 STATUS INDICATOR

This **blue LED** will illuminate and indicates that the amplifier is on and receiving mains power.

It can also flash to indicate status information as shown in the following table:

FLASHES	MEANING	FREQUENCY OF
Fast	Front panel button press detected	Off 75ms=On 75ms-Repeat
Blinking	Standby Mode	Off 4s-50ms Flash-Repeat
1-Slow	Priority mode triggered	Off 1s-On 1s-Off 1s-On
1	SD card absent or faulty	Off 2s-1 300ms Flash
2	SD card folder error	Off 2s-2 300ms Flashes
3	SD card file error	Off 2s-3 300ms Flashes

See the **Fault Finding** section of this manual to fix any errors displayed.

### 3 PROTECT INDICATOR

The following table indicates the meaning of each protection mode:

LED	Meaning
Yellow flashing	Amplifier temperature warm
Yellow on	Amplifier temperature hot
Red flashing	Amplifier over temperature*
Red on	Amplifier protect
Red/Yellow flashing	USB power fault
Red on (Status LED off)	Amplifier in Service Mode

See the **Fault Finding** section of this manual to fix any errors displayed.

\* In the advent of a thermal overload, the internal operating temperature of the amplifier has exceeded a safe level of operation. Please wait for the amplifier to cool, at which point it will return to normal operation.

### 4 CHANNEL SIGNAL / CLIP INDICATOR

A **green LED** will illuminate to show a signal is present on the corresponding audio input channel. A **red LED** will illuminate when clipping occurs due to an excessive input signal. If clipping occurs adjust the gain/trim potentiometer of the corresponding channel counter-clockwise until the **green LED** is illuminated.

### 5 MASTER OUTPUT METER

The LEDs will illuminate in sequence from -40dB to clip level based on the input signal level to the amplifier. The **red LED** will illuminate when clipping occurs, turn down the master volume to prevent clipping.

**!** **Note:** The amplifier is not damaged by running into clipping, but speakers may be. To maximise the life of your speakers, try to keep clipping infrequent.

### 6 SD CARD CONNECTOR

Input connector for a full size SD card to be used with the music player or tone generator. Maximum density support up to 2TB. Consult the **Support of SD cards larger than 32GB** section for further details.

**!** **Note:** Format the card to the FAT32 file system. Use a full size SD card adapter to support mini or micro sized SD cards.

### 7 3.5MM LINE INPUT SOCKET

Audio input socket for use with mobile devices or portable equipment.

### 8 CHANNEL VOLUME CONTROL

Turn the control clockwise to increase the level of the corresponding channel.

### 9 MUSIC PLAYER CONTROLS

Consult the **Music Player** section of this manual for further details of these controls.

### 10 BLUETOOTH®

Consult the **Bluetooth® Audio Streaming** section of this manual for further details of these controls.

### 11 USB CHARGER

USB charging port for mobile devices. It provides 500mA of charge current at 5V.

### 12 MASTER VOLUME CONTROL

Turn the control clockwise to increase the level of the mixer output.

# CONTROLS, CONNECTORS & INDICATORS

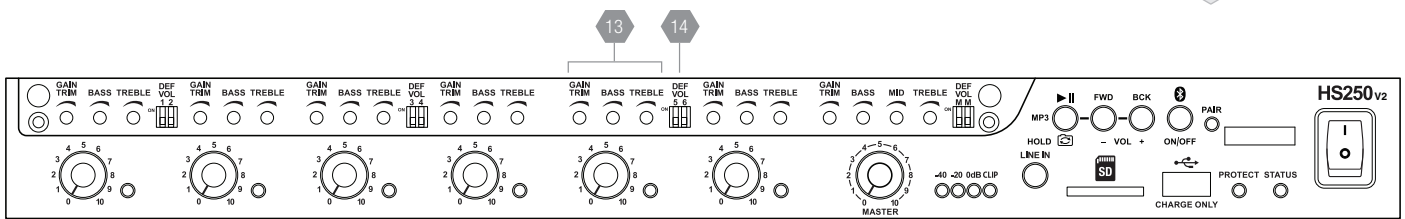

Front panel, cover removed

## FRONT PANEL CONTINUED

### 13 GAIN / TRIM AND EQUALISER

Turn the corresponding channels potentiometer clockwise to increase the gain, bass, mid or treble and counter-clockwise to decrease.

The 12 o'clock position sets each control to its centre position of 0dB.

The **GAIN/TRIM** has a range of  $\pm 12$ dB.

The equaliser has an adjustable range:

- Bass 100Hz  $\pm 12$ dB
- Mid 1600Hz  $\pm 12$ dB
- Treble 10kHz  $\pm 12$ dB

### 14 DEFEAT VOLUME CONTROL

You can defeat/disable the mixer's volume controls to prevent end users interfering with the system volume.

Place the DIP switch in the DOWN position to disable the volume control.

Use the GAIN/TRIM potentiometer to modify the audio level instead of the volume controls during installation.

**⚡ WARNING:** Disabling the volume controls will pass through high audio signal levels. Turn down the gain/trim pots to prevent excessive audio output and then increase to find a suitable output level.

# CONTROLS, CONNECTORS & INDICATORS

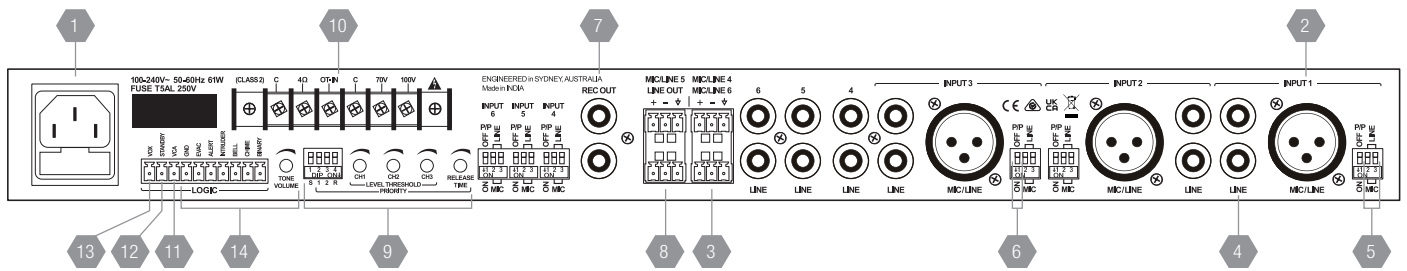

## REAR PANEL

- 1 MAINS INPUT CONNECTOR**  
Your amplifier is fitted with a standard IEC 60320-C14 socket for mains connection. Use the mains cable supplied to power up the unit.

**⚠ Note:** Your unit must always be earthed!
- 2 XLR MIC/LINE BALANCED INPUT, CH1-3**  
A standard female XLR balanced socket is provided on each input:  
**Pin 1** = Signal Ground  
**Pin 2** = Hot (non-inverting or in phase)  
**Pin 3** = Cold (inverting or reverse phase)
- 3 PHOENIX MIC/LINE BALANCED INPUT, CH4-6**  
A balanced male 3-pin (3.81mm) Phoenix type connector is provided on each input:  
**Pin 1** is the left-most pin when viewed from the back of product.  
**Pin 1** = Hot (non-inverting or in phase)  
**Pin 2** = Cold (inverting or reverse phase)  
**Pin 3** = Signal Ground
- 4 STEREO RCA UNBALANCED INPUT**  
A standard stereo RCA female socket for each input. This is summed to mono inside the mixer.
- 5 MIC/LINE LEVEL INPUT SELECTOR**  
Turn both DIP switches DOWN for MIC level input range or UP for line level input range.

**⚠ Note:** Both DIP switches must be up or down. Do **NOT** have one switch up and one down.
- 6 PHANTOM POWER**  
Press the DIP switch DOWN to output 12V phantom power on the corresponding XLR balanced input connector. Phantom power is **NOT** outputted on the RCA connectors.

**⚠ Note:** To avoid potentially damaging audio spikes to connected equipment, turn off the product before enabling phantom power.
- 7 RECORD OUTPUT**  
A standard stereo RCA output containing the pre-master mixer stage output signal – i.e. Pre-Master volume control potentiometer, Pre-Amplifier.
- 8 LINE LEVEL OUTPUT**  
A balanced male 3-pin (3.81mm) Phoenix type connector output containing the master mixer stage output signal – i.e. Post-Master volume potentiometer, Pre-Amplifier.
- 9 PRIORITY CONTROL**  
Consult the **Priority Control** section of this manual for further detail of these controls.
- 10 SPEAKER OUTPUTS**  
The class D amplifier output features 100V Line, 70V Line or 4 Ohm low impedance.

**⚠ Note:** Only one output type should be used at a time.
- 11 VCA CONTROL/MASTER MUTE**  
External Voltage Controlled Attenuation (VCA) /Master mute input.  
Consult the **Voltage Controlled Attenuation (VCA)** section of this manual for further detail of this control.
- 12 STANDBY INPUT**  
Connect this signal to ground (GND) to enable standby mode.  
Consult the **Standby Input** section of this manual for further detail of this control.
- 13 VOX OUTPUT**  
Open collector transistor output to indicate priority mode is active. Connect this to an external control system.  
Consult the **VOX Output** section of this manual for further detail of this control.
- 14 TONE/MP3 GENERATOR CONTROL**  
Consult the **Tone Generator and Binary Input Trigger** section of this manual for further detail of these controls.

# BLOCK DIAGRAM



## CHANNEL STAGE

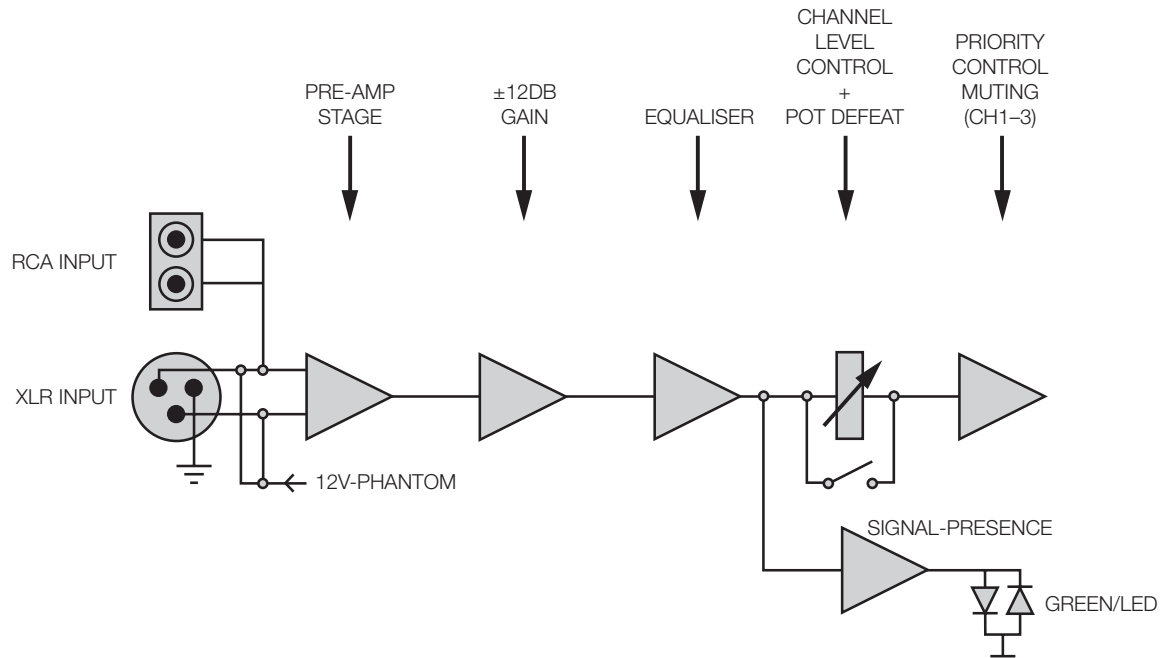

## MIXER STAGE

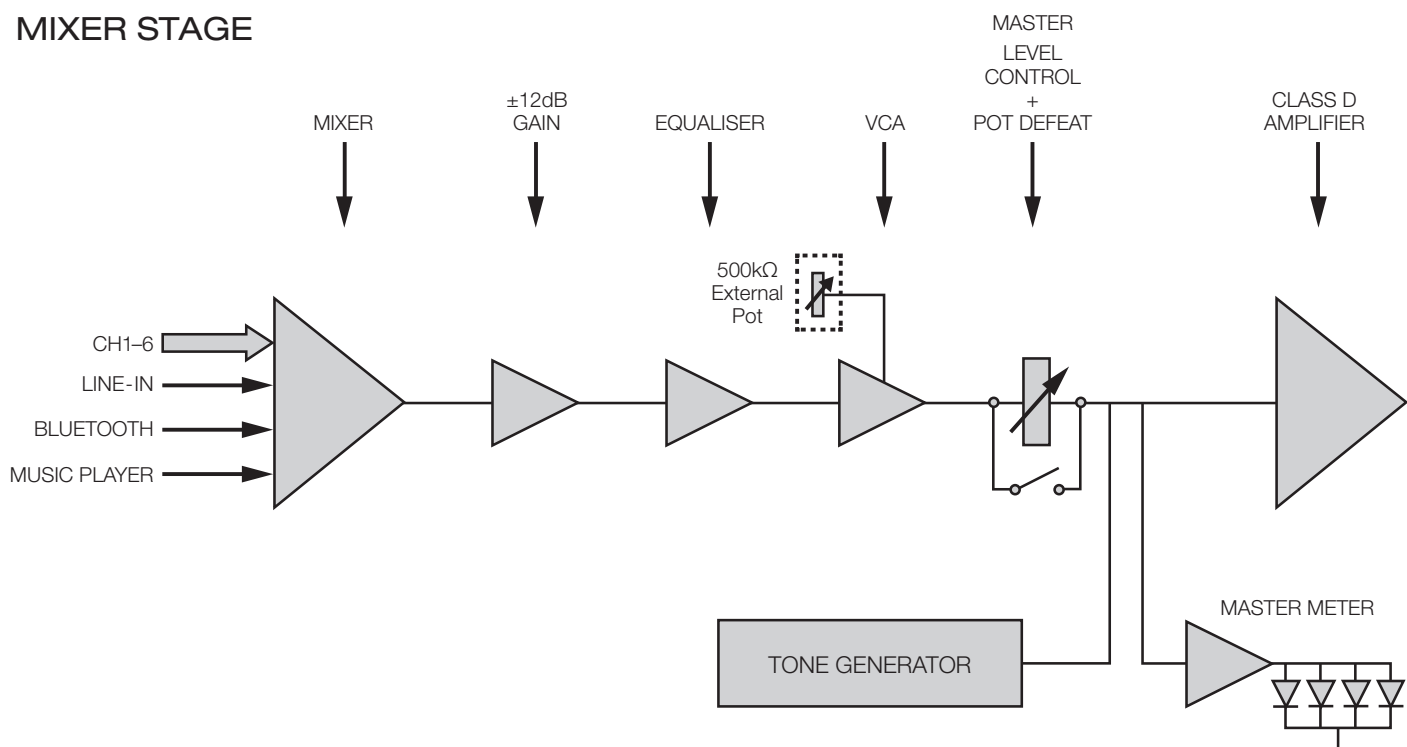



# INSTALLATION

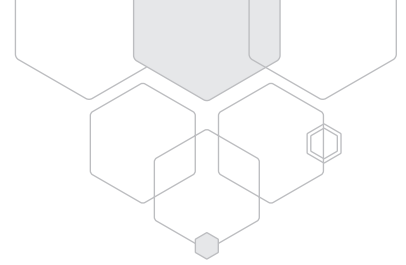

## POWER REQUIREMENTS

Power consumption for your model of the HS series mixer amplifier is indicated on the rear panel for 1/8th output power.

Ensure that your mains voltage is the same as the rear panel mains voltage marker (+/- 10%).

## MOUNTING

The HS series mixer amplifiers are one rack unit high (1U) and will fit a standard EIA 19" rack.

Typically, amplifiers may be stacked directly on top of each other with no need for spacing between units, unless installed in high ambient temperature environments where a single rack unit space between amplifiers will assist cooling further.

## COOLING

The HS60 and HS120 amplifiers are convection cooled and do not require any special consideration.

The HS250 amplifier is cooled by axial fans which draw air from the right side of the amplifier and expel the heated air out the left side of the amplifier. These amplifiers offer variable speed fans which run at half speed up to full speed when the internal heatsink temperature increases.

An unrestricted airflow into and out from the amplifier must be provided. Any restriction of the air flow will cause heat to build up within the unit and possibly force the unit into its thermal shutdown mode.

If the amplifiers are to be operated in an environment where the airflow is restricted such as sealed racks, cooling should be supplemented by extra cooling fans to evacuate the heated air and aid the flow of cool air through the unit.

## BALANCED INPUT WIRING

 **WARNING:** Input signal ground should NOT be used as a safety ground (earth).

The balanced input to the mixer is 3-pin configuration and requires all three pins to be connected. Only high quality twin-core shielded cable should be used.

**Pin 1** = Signal Ground

**Pin 2** = Hot (non-inverting or in phase)

**Pin 3** = Cold (inverting or reverse phase)

When wiring from an unbalanced source you must ensure that pin 3 is connected to pin 1 (input ground), either by linking the pins in the input connector or by the source equipment's output wiring.

When wiring for an unbalanced source:

**Pin 1** = Signal Ground

**Pin 2** = Hot (non-inverting or in phase)

**Pin 3** = Signal Ground

## OUTPUT WIRING

When wiring to your speakers always use the largest gauge wire your connector will accept. The longer the speaker lead the greater the losses which will result in reduced power and less damping at the load  $4\Omega$ . We recommend using a heavy duty, two core flex (four core flex if bi-amping) 10 to 12 gauge (2mm<sup>2</sup> to 2.5mm<sup>2</sup> or 50/0.25 or equivalent) as a minimum.

## 100V LINE CABLE DIAMETER AND LENGTH

	0.75mm <sup>2</sup>	1.0mm <sup>2</sup>	1.5mm <sup>2</sup>	2.5mm <sup>2</sup>	4.0mm <sup>2</sup>	6.0mm <sup>2</sup>
30 Watt	800m	1066m	1600m	2666m	4266m	6400m
60 Watt	400m	533m	800m	1333m	2133m	3200m
120 Watt	200m	266m	400m	666m	1066m	1600m
240 Watt	100m	133m	200m	333m	533m	800m

# INSTALLATION (CONT)

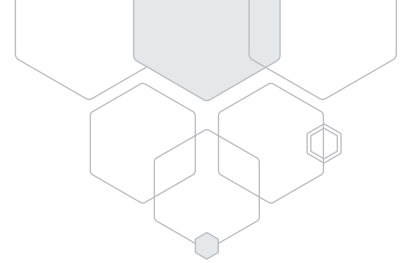

## SPEAKER OUTPUT SETUP

The amplifier output has a 6 pin output screw terminal with a pre-fitted link between the 4Ω and the high impedance output. Follow the instructions below to connect the amplifier to your speaker/s for each output mode.

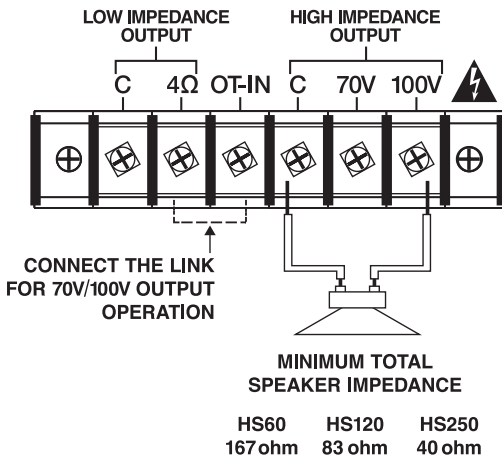

### 100V

- Fit the link between 4Ω and the OT-IN. (This connects the amplifier output to the input of the 70/100V transformer)
- Connect your speaker to the HIGH IMPEDANCE OUTPUT 'C' and '100V' connections

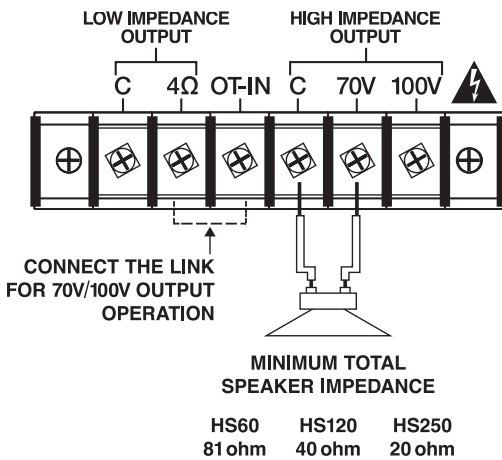

### 70V

- Fit the link between 4Ω and the OT-IN. (This connects the amplifier output to the input of the 70/100V transformer)
- Connect your speaker to the HIGH IMPEDANCE OUTPUT 'C' and '70V' connections

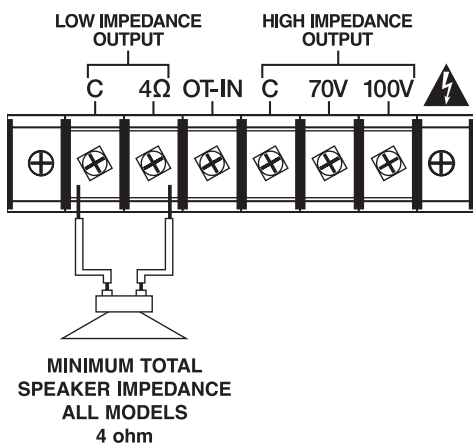

### 4Ω OR 8Ω OPERATION

- Remove the link between 4Ω and the OT-IN
- Connect your speaker to the LOW IMPEDANCE OUTPUT 'C' and '4Ω' connections

# INSTALLATION (CONT)

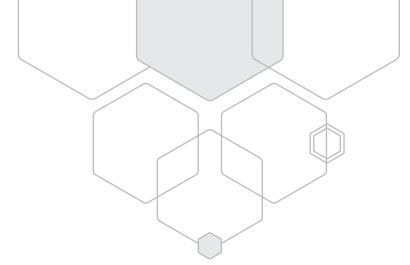

## HUM PROBLEMS

Most equipment is designed for minimum hum when used under ideal conditions. When connected to other equipment, and to a safety earth in an electrically noisy environment, problems may occur.

The three "E"s of hum and hum related noise which can plague your audio system are:

- a) Earth loops
- b) Electromagnetic radiation
- c) Electrostatic radiation

Earth loops can arise from the interfacing of the various pieces of equipment and their connections to various safety earths.

This is by far the most common cause of hum, and it occurs when source equipment and the mixer are plugged into different points along the safety earth where the safety earth wiring has a current flowing through it. The current flowing through the wire produces a voltage drop due to the wire's resistance. This voltage difference between the mixer earth and source equipment earth appears to the mixer's input as a signal and is amplified as hum. **There are three things you can do to avoid earth loop problems:**

- Ensure the mains power for the audio system is "quiet" i.e. without equipment on it such as air-conditioning, refrigeration or lighting which may generate noise in the earth circuit.
- Ensure all equipment within the system shares a common ground/ safety earth point. This will reduce the possibility of circulating earth currents, as the equipment will be referenced to the same ground potential.
- Ensure that balanced signal leads connecting to the mixer are connected to earth at one end only.

Electrostatic radiation capacitively couples to system elements, causing an interference voltage that mainly affects higher impedance paths, such as mixer inputs. The source is generally a nearby high voltage, such as a mains lead or a speaker lead. The problem can usually be reduced by moving the offending lead away, or by providing additional electrostatic shielding (i.e. an earthed conductor which forms a barrier to the field).

Electromagnetic radiation induces interference currents into system elements that mainly effect lower impedance paths. Radio transmitters or stray magnetic fields from mains transformers are often the cause of this problem. It is generally more difficult to eliminate this kind of interference, but again, moving the source away or providing a magnetic shield (i.e. a steel shield) should help.

## POWERING UP

 **REMEMBER:** The amplifier should be the last piece of equipment that you turn on and the first piece of equipment that you turn off. We recommend tuning the master volume potentiometer down while power cycling the unit.

## SENSITIVITY

Each channel of your HS series mixer amplifier has a nominal balanced input impedance of 30kOhms (@1kHz) and should not present a difficult load for any signal source.

Your signal source (i.e. the equipment feeding signal to the mixer) should have an output impedance of 600 Ohms or lower to avoid unwanted high frequency loss in the cabling.

# BASIC SETUP & OPERATION

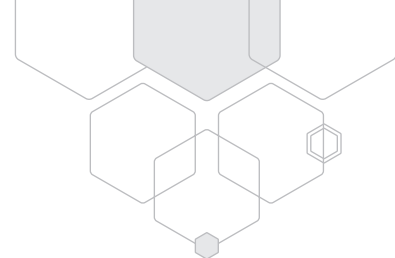

The inputs of the HS mixer amplifiers can accommodate a wide range of sources including dynamic microphones, DVD and CD players.

Each installation will require setting the appropriate relative mix of levels between microphones and program sources. Due to the variation in levels between the possible sources, the HS amplifiers offers a number of gain stage adjustments in order to set the correct levels for your application.

Setting up correct gain structure through the whole system is important to achieve optimal results. The following step by step setup has been devised to assist during the setup process.

## INITIAL SETTINGS (FACTORY DEFAULT)

- Channel/Master Gain and Equaliser Controls. Set to 0dB (12 o'clock)
- XLR Mic/Line switches – MIC (DIP switches down)
- XLR Phantom power switch – OFF (DIP switch up)

## STEP BY STEP SETUP

### 1 CONNECT THE SOURCES

First connect all the required sources to the appropriate input connectors. If the source is a microphone, set the MIC/LINE switches to the 'MIC' position (down). If the source is an electret or condenser microphone, set the phantom switch 'P/P' to the DOWN position (on).

### 2 TEST THE INPUT LEVELS

For each source, try to achieve the highest signal level possible. i.e. for a CD player, cassette deck or other music source, put on the loudest anticipated program music or for a paging mic make a 'loud' page. During this signal condition, the input status LED should light green and may occasionally turn red for a short period. If the status LED stays red (more than 10% of the time), you should reduce the input 'GAIN/TRIM'. If the status LED never turns red at all, you may wish to increase the input gain trim if required.

### 3 SET THE LEVELS

Turn the channel input volume controls up to 5 on each channel being used. Turn up the master volume control until it is at an appropriate level for the listening environment. Now adjust the relative levels of each of the input channels to achieve a good balance. The aim of these adjustments is to have all level controls at between 3 and 7. This may not be possible however. A good rule of thumb is that input level controls should be higher than the output level controls.

### 4 TURN DOWN UNUSED CHANNELS

All input channels add noise into the system. To maximise the performance of your system turn down any unused channel volume controls.

### 5 TONE GENERATOR

The tone generator volume control is independent (bypasses) the volume controls of the system and directly feeds the mixer output. Close the EVAC contact on the 10 way Phoenix connector and then adjust the TONE VOLUME trim pot to an appropriate level.

# OPERATION

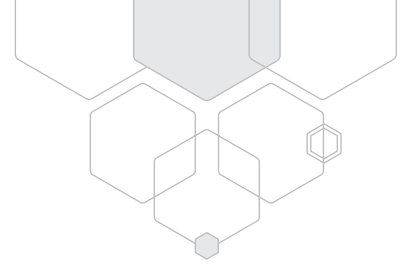

## VOLUME CONTROLS

The diagram below shows the volume control stages of the HS mixer amplifier.

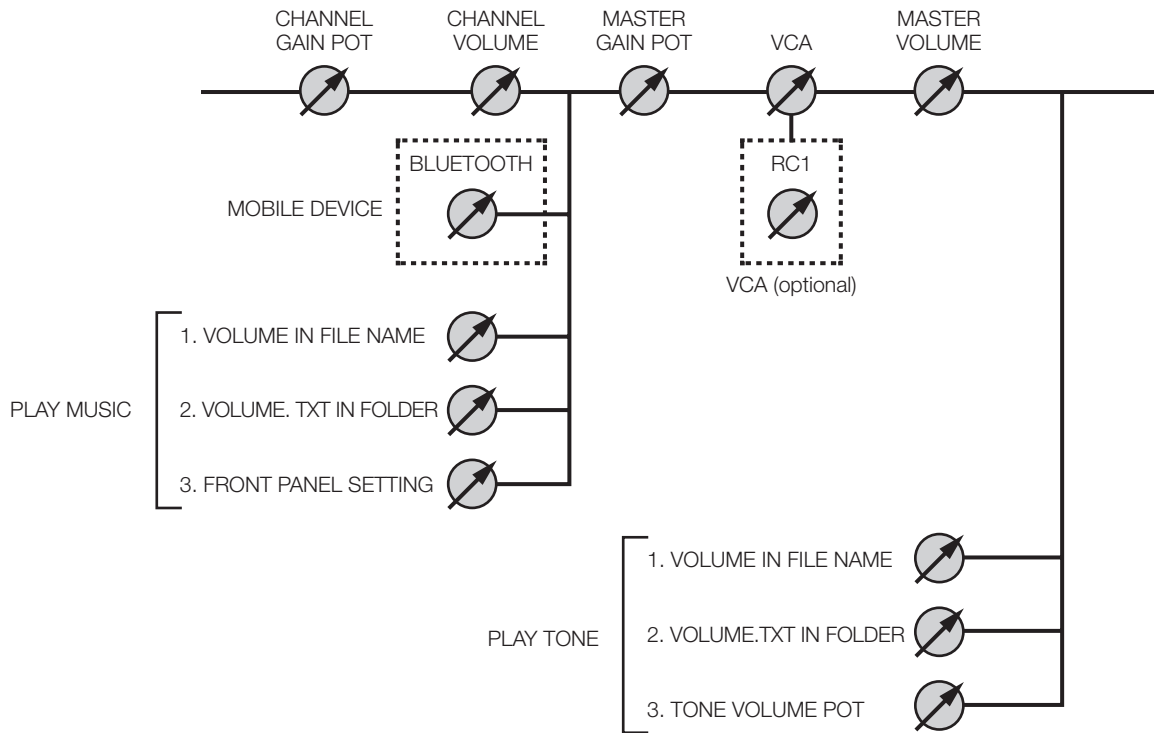

# OPERATION CONT.

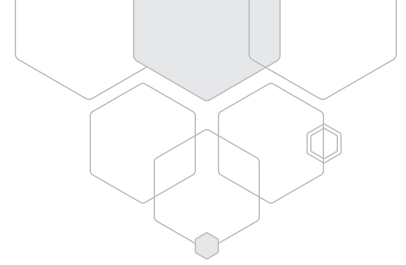

## TONE GENERATOR

The HS mixer amplifier ships as standard with 5 factory programmed default tones.

Tones can be played by shorting the appropriate contact to GND on the back panel 10 way Phoenix connector.

**⚠ IMPORTANT:** Do **NOT** drive external voltages into the pins (except VOX) or damage to the unit will occur.

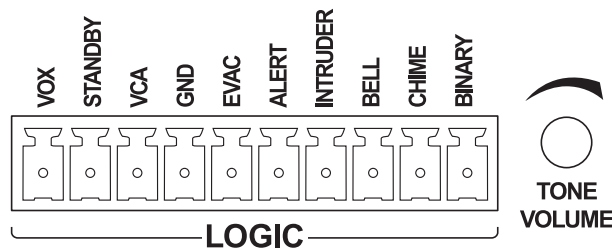

## TONES

- 1) **'EVAC'**: a long continuous repeating tone with a ramped frequency. Triggered by shorting EVAC to GND, the sound will continue to repeat until the short is released.
  - 2) **'ALERT'**: a short tone burst tone repeated every 0.5s. Triggered by shorting ALERT to GND, the sound will continue to repeat until the short is released.
  - 3) **'INTRUDER'**: a two tone 'low' 'high' alert repeating every 0.4s. Triggered by shorting INTRUDER to GND, the sound will continue to repeat until the short is released.
  - 4) **'BELL'**: a short repeating tone burst with decay and reverb. Triggered by shorting BELL to GND, the sound will continue to repeat until the short is released.
  - 5) **'CHIME'**: a four note increasing tone suitable for paging preannouncement. Triggered by shorting CHIME to GND, it will sound only once for each time the trigger is activated. Please note: 'CHIME' tone must play to completion before it may be retriggered.
- To activate a tone trigger input, short the relevant input to GND. The selection must be stable for longer than 150ms.
  - Each tone is played to completion even if the trigger selection is removed during playback.
  - A higher priority tone trigger will interrupt a lower priority tone being played. Consult the priority table below to see which selection takes precedence.
  - After deselection and completion of playing a higher priority tone, any selected lower priority tone will be played. Exceptions are BELL and CHIME tones which will not be played.
  - **During tone playback:**
    - > **EVAC, ALERT and INTRUDER** tone playback mute all channels except Ch1 with channel priority selection not honoured (disabled).
    - > **BELL and CHIME** tone playback mute all channels except Ch1 to Ch3 with channel priority selection honoured (enabled).
    - > The front panel MP3 buttons are ignored.
  - **After deselection and playback completion of all tones:**
    - > Any previous continuous playback from 'sequence' or 'random' folders will be restored.
    - > Channel priority selection will be honoured (enabled).

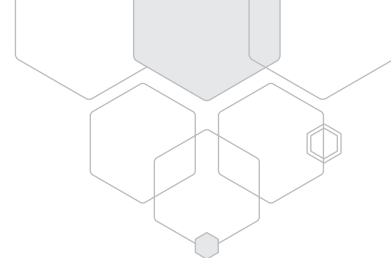

## TONE GENERATOR PRIORITY

The following table shows the priority level of which tone is played.

CHIME	BELL	INTRUDER	ALERT	BINARY	EVAC	PRIORITY	FUNCTION
X	X	X	X	X	<b>GND</b>	Highest	Play EVAC tone. Repeat while selected.
X	X	X	X	<b>GND</b>	OPEN		Play Binary selection.
OPEN	OPEN	OPEN	<b>GND</b>	OPEN	OPEN		Play ALERT tone. Repeat while selected.
OPEN	OPEN	<b>GND</b>	OPEN	OPEN	OPEN		Play INTRUDER tone. Repeat while selected.
OPEN	<b>GND</b>	OPEN	OPEN	OPEN	OPEN		Play BELL tone. Repeat while selected.
<b>GND</b>	OPEN	OPEN	OPEN	OPEN	OPEN	Lowest	Play CHIME tone once.

**LEGEND:** **GND** = Contact is shorted to GND pin      **OPEN** = Input contact is floating/not connected to GND pin  
**x** = OPEN or GND. See the Binary Input Trigger section for information on Binary selection combination options

## TONE VOLUME SETTING

The tone volume is controlled using the '**TONE VOLUME**' control on the back panel. Increase the volume by turning the POT clockwise and counter-clockwise to decrease the volume. The MASTER volume control does NOT affect the tone volume.

**NOTE:** If different tone volume levels are required, use an SD card and store the tones with the volume setting attached to the file name.

## OVERRIDING DEFAULT TONES USING AN SD CARD

The default tones of the mixer can be overridden by added tones to a user supplied SD card.

Simply place the tone MP3 or WAV file on the root of the SD card and it will be played instead of the inbuilt tone. (See the **Tone File/Folder Structure and Format** section for further information on this feature.)

In addition, the volume for each custom tone can be customised when using the SD card by adding the required volume to the filename.

### Examples

evac.mp3	evacuation tone which will override factory default tone
intruder_75.mp3	intruder tone which will override factory default tone and set volume to 75

**NOTE:** If the tone on the SD card is unplayable, e.g due to being the wrong format, a fault code will flash on the **STATUS LED** and the default tone will be played instead with a volume level set by the **TONE VOLUME POT**.

### USER DEFINED TONES USING AN SD CARD

The HS mixer amplifiers tone generator features can be extended beyond the **EVAC, ALERT, INTRUDER, BELL** and **CHIME** tones. Additional user generated tones can be placed on an SD card and played using the back panel 10-way Phoenix connector.

**NOTE:** It is not restricted to playing tones – any MP3 or WAV file can be played. e.g. an audio music file.

### FEATURES:

- Up to 11 additional user generated tones
- Each tone can have a unique volume level
- Each tone can individually enable or override the priority mode function. This allows a tone to be configured to mute all channels and allow audio inputs from only Channel 1, 2 or 3.

### METHOD:

Place the tone files on the SD card following the File Format: Trigger Number \_ Track Name \_ mixN\_Volume.mp3 as described in the **User Defined Tones** section of the manual.

### EXAMPLE:

3\_Track Name\_mix1\_75.mp3 (Trigger input 3 with track name, Priority set to Ch1 active all others muted, volume set to 75).

Play the tone by sending the appropriate binary trigger input combination to the 10 way Phoenix connector.

The format of the input trigger is described in the **Binary Input Trigger** section of the manual.

# OPERATION CONT.

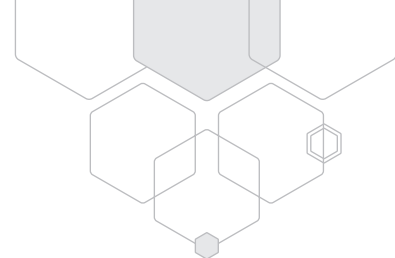

## BINARY INPUT TRIGGER

The 10 way Phoenix connector on the back panel features a special BINARY input pin, by pulling this pin low it allows combinations of input triggers on the connector to perform additional features.

- Ability to play up to 11 additional customer specified tones.
- Initiate playback from the sequence or random playlist folders.
- Stop playing the current tone or music.

**NOTE:** If you are using the binary trigger input functions (BINARY connected to GND), this will override the chime, bell, intruder and alert tone input functions. The EVAC tone input is NOT affected by the binary input trigger and will always play the evacuation tone when triggered.

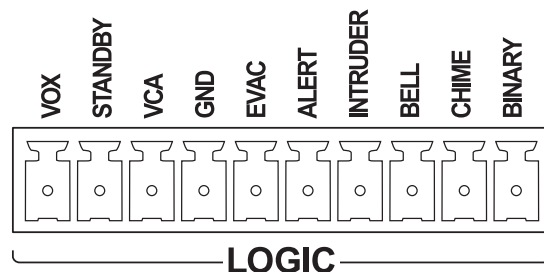

The table below shows the trigger combinations. Connect the appropriate logic input to the GND pin to activate the function.

BINARY	CHIME	BELL	INTRUDER	ALERT	EVAC	FUNCTION
<b>GND</b>	OPEN	OPEN	OPEN	OPEN	OPEN	Stop all playback immediately (except EVAC, ALERT and INTRUDER)
<b>GND</b>	<b>GND</b>	OPEN	OPEN	OPEN	OPEN	Continuously play files from the 'random' folder. <b>Momentary contact.</b>
<b>GND</b>	OPEN	<b>GND</b>	OPEN	OPEN	OPEN	Continuously play files from the 'sequence' folder. <b>Mo mentary contact.</b>
<b>GND</b>	OPEN	OPEN	<b>GND</b>	OPEN	OPEN	Play one file from the 'random' folder.
<b>GND</b>	OPEN	OPEN	OPEN	<b>GND</b>	OPEN	Play one file from the 'sequence' folder.
<b>GND</b>	<b>GND</b>	<b>GND</b>	OPEN	OPEN	OPEN	Play file #1 (1_abc_xxx.wav). Repeat while selected.
<b>GND</b>	<b>GND</b>	OPEN	<b>GND</b>	OPEN	OPEN	Play file #2 (2_abc_xxx.wav). Repeat while selected.
<b>GND</b>	<b>GND</b>	OPEN	OPEN	<b>GND</b>	OPEN	Play file #3 (3_abc_xxx.wav). Repeat while selected.
<b>GND</b>	OPEN	<b>GND</b>	<b>GND</b>	OPEN	OPEN	Play file #4 (4_abc_xxx.wav). Repeat while selected.
<b>GND</b>	OPEN	<b>GND</b>	OPEN	<b>GND</b>	OPEN	Play file #5 (5_abc_xxx.wav). Repeat while selected.
<b>GND</b>	OPEN	OPEN	<b>GND</b>	<b>GND</b>	OPEN	Play file #6 (6_abc_xxx.wav). Repeat while selected.
<b>GND</b>	<b>GND</b>	<b>GND</b>	<b>GND</b>	OPEN	OPEN	Play file #7 (7_abc_xxx.wav). Repeat while selected.
<b>GND</b>	<b>GND</b>	<b>GND</b>	OPEN	<b>GND</b>	OPEN	Play file #8 (8_abc_xxx.wav). Repeat while selected.
<b>GND</b>	<b>GND</b>	OPEN	<b>GND</b>	<b>GND</b>	OPEN	Play file #9 (9_abc_xxx.wav). Repeat while selected.
<b>GND</b>	OPEN	<b>GND</b>	<b>GND</b>	<b>GND</b>	OPEN	Play file #10 (10_abc_xxx.wav). Repeat while selected.
<b>GND</b>	<b>GND</b>	<b>GND</b>	<b>GND</b>	<b>GND</b>	OPEN	Play file #11 (11_abc_xxx.wav). Repeat while selected.

### NOTES:

- To activate the selection, short the relevant inputs to GND. The combination of trigger inputs must all be grounded within 100ms of each other. The selection must then be stable for longer than 150ms once all required inputs are grounded.
- During playback:
  - > For custom tone #1 to #11 or single file playback from folders, the front panel MP3 buttons are ignored.
  - > For any continuous selection playback, the front panel MP3 buttons are functional.
- Any new binary trigger selection will stop the current playback and play the new selection immediately.
- Playback will continue to file completion if the trigger selection is removed during playback. However, 'continuously play' binary selections will continue to play indefinitely.
- The 'continuously play' folders binary selections are momentary. i.e they will keep playing if the trigger input is removed. To stop playback, issue a 'Stop all playback' command or press the front panel 'play/pause' button.
- On completion of file #1-11 playback, any previous playback from 'sequence' or 'random' folders will be restored.
- On completion of 'Play one file' playback, any previous playback from sequence' or 'random' folders will **NOT** be restored.
- The EVAC tone trigger input has priority over any BINARY selection.
- A Binary stop command will:
  - > stop BELL & CHIME tone playback immediately.
  - > stop playback immediately from track 1 to 11, sequence or random track play on SD card.
  - > play EVAC, ALERT and INTRUDER tone playback to completion, then stop.



# OPERATION CONT.

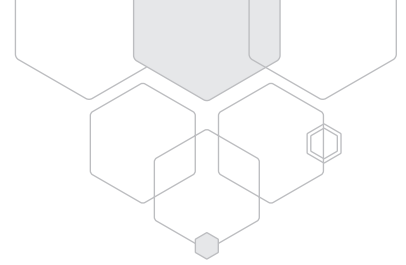

## PRIORITY CONTROL

The HS mixer amplifiers feature priority mode detection which allows channels to be muted when audio is detected on channels 1–3. This can be used for applications like paging where background music is muted while the announcement occurs.

The priority section consists of three DIP switches and four POTS to configure the operation.

- DIP switches labelled ‘1’ and ‘2’ set the MODE
- DIP switch ‘R’ sets the release (unmute) time.
- RELEASE TIME POT sets the time to release (unmute) the mixer after a priority mute event.
- CH1-3 LEVEL THRESHOLDS set the audio trigger level for each channel

Note: Do NOT turn on the ‘S’ switch which puts the unit into service mode.



1	2	PRIORITY MODE
OFF	OFF	No Priority
OFF	ON	CH1
ON	OFF	CH1 then CH2 then CH3
ON	ON	CH1 and CH2 then CH3

R	RELEASE TIME
OFF	1 to 5 seconds
ON	1 to 25 seconds

### 1. MODE.

The priority mode can be enabled and configured using the DIP switches ‘1’ and ‘2’. See the table above to configure which channel has the priority when audio is detected.

### 2. RELEASE TIME.

There are two controls used in combination to set the release (unmute) time. DIP switch ‘R’ sets the adjustable range of the RELEASE TIME POT.

- OFF = 1-5 seconds
- ON = 1-25 seconds

**RELEASE TIME POT.** Set this trim pot to the desired release (unmute) time after a priority channel audio signal is no longer present. Turn clockwise to increase the release time.

### 3. LEVEL THRESHOLD.

These three pots control the level at which the audio input triggers the priority control. Turning the trim pot clockwise sets the threshold higher so that a louder signal is required before muting occurs. Note that when the module is set to have channel 1 and 2 at equal levels of priority, the thresholds for each channel are still set individually.

# OPERATION CONT.

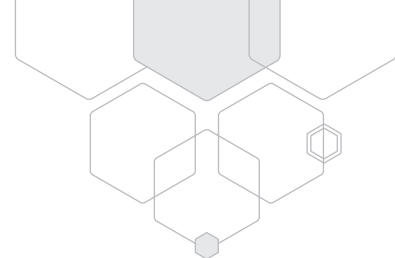

## MUSIC PLAYER

The mixer also includes an audio MP3/WAV player which can play an unlimited number of files stored on a user supplied SD card.

Music files should be stored in the 'sequence' or 'random' folders of the SD card. These can then be played from either the front panel controls or the 10 way back panel Phoenix connector (using the continuous play commands).

Consult the **SD Card Format** section of this manual on how to place the music files on the SD card.

**NOTE:** During tone playback, the front panel music player buttons are ignored.

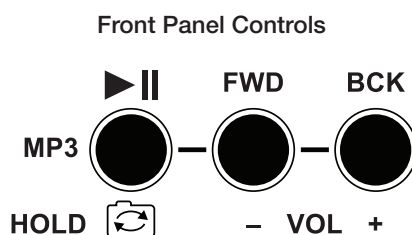

Each button has two associated actions dependant on the duration of the button press. These are:

BUTTON POSITION	SHORT PRESS ( < 500MS )	LONG PRESS ( > 500MS )
Left	Play/Pause	Swap Folder
Middle	Next Track (FWD)	Volume Down
Right	Previous track (BCK)	Volume Up

### SHORT PRESS ACTION:

BUTTON	ACTION
Play/Pause	When idle, play the next file in the selected folder from the SD Card. When playing, pause the playback. When paused, continue playing from when pause occurred.
Next Track	When playing, skip to the start of the next file in the selected folder on the SD Card.
Previous Track	When playing, skip to the start of the previous file played. If no previous file exists, restart current file.

### LONG PRESS ACTION:

BUTTON	ACTION
Swap Folder	Swap between 'random' and 'sequence' folders in the root of the SD Card. This action will stop the playback and delete playback history.
Volume Down	Ramp the MP3 player track volume down to minimum level while button pressed.
Volume Up	Ramp the MP3 player track volume up to maximum level while button pressed.

### MUSIC PLAYER VOLUME CONTROL

The volume control of the music player can be set by individual track, folder volume or the front panel volume control buttons. The priority of which volume is used is as follows:

PRIORITY	VOLUME SETTING	EXAMPLE
Highest	Track Name	Track_75.mp3
	Folder	volume.txt file (See page 22 of manual for an example)
Lowest	Default	Front panel volume

# OPERATION CONT.

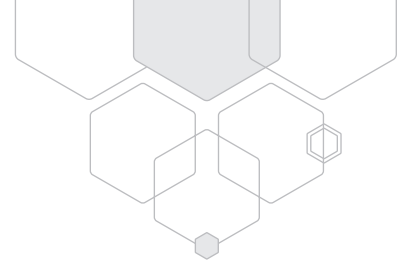

## BLUETOOTH® AUDIO STREAMING

The HSv2 series includes a Bluetooth® Audio streaming interface which can receive audio from any device like a mobile phone, computer or tablet. Simply connect your Bluetooth® device and it will mix in to the amplifier output.

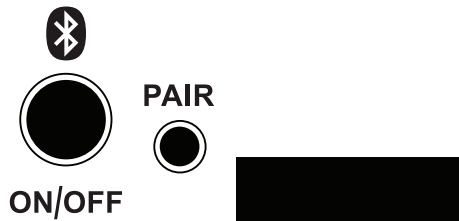

Defaults:  
Bluetooth Device Name: HS250-XXXX  
Passcode/PIN: 2626 (AMAM)

### BLUETOOTH® CONNECTION

1. Press the ON/OFF button to activate Bluetooth and enter pairing mode
2. On your Bluetooth® source device, e.g. a mobile phone, select the HS Bluetooth name. E.g. HS250-4763. Consult the source device's manual about accessing the Bluetooth® connection options.
3. Your Bluetooth® device will ask for a passcode/PIN. Default PIN: 2626
4. The PAIR LED will then flash 10 times to indicate successful pairing
5. Play audio from your Bluetooth® device.
6. Hold down the ON/OFF button for 5 seconds to turn the Bluetooth module off

### BLUETOOTH® CONNECTION RANGE

The Bluetooth® connection range is a minimum of 10 meters. However, range is typically much larger but not guaranteed.

### CONNECTING A DIFFERENT BLUETOOTH® DEVICE

The Bluetooth® module can only support one device connection at a time.

If you need to change devices, repeat the Bluetooth® connection process described above. By entering pairing mode it disconnects the current device and allows a new device to be connected.

### POWER OFF THE BLUETOOTH® DEVICE

To power off the Bluetooth® module hold down the Bluetooth® ON/OFF button for 5 seconds.

**⚠ IMPORTANT:** Ensure that the volume of your Bluetooth® device is set to an appropriate level as this effectively adds in another volume control to your system.

**⚠ NOTE:** The Bluetooth® module is powered off as standard when turning the amplifier on to maximise security. If the amplifier is power cycled you must turn the Bluetooth® module back on by pressing the Bluetooth® ON/ OFF button.

# OPERATION CONT.

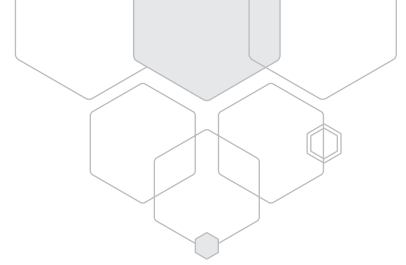

## BLUETOOTH® AUDIO STREAMING (CONT.)

### PROGRAMMABLE BLUETOOTH® SETTINGS

The HS<sub>v2</sub> adds the capability to customise the settings of the Bluetooth module by programming new settings via the SD card connector. Using the **Bluetooth Control Software**, available on the Australian Monitor website, create a programming file to upload to the HS<sub>v2</sub> via the SD card connector.

Step 1 – Download, install and open the **Bluetooth Control Software** from the Australian Monitor website

Step 2 – Select the HS<sub>v2</sub> product from the product selector

Step 3 – Enter the required Bluetooth configuration

Step 4 – Select “Export Bluetooth Configuration” button and save the file to the ROOT of an SD card

⚠ The SD card must be formatted to FAT32 format. Further details are on page 21.

Step 5 – Turn OFF the HS<sub>v2</sub> mixer amplifier and insert the SD card

Step 6 – Turn ON the HS<sub>v2</sub> mixer amplifier (The unit will read the SD card and program the Bluetooth settings)

Step 7 – Remove the SD card

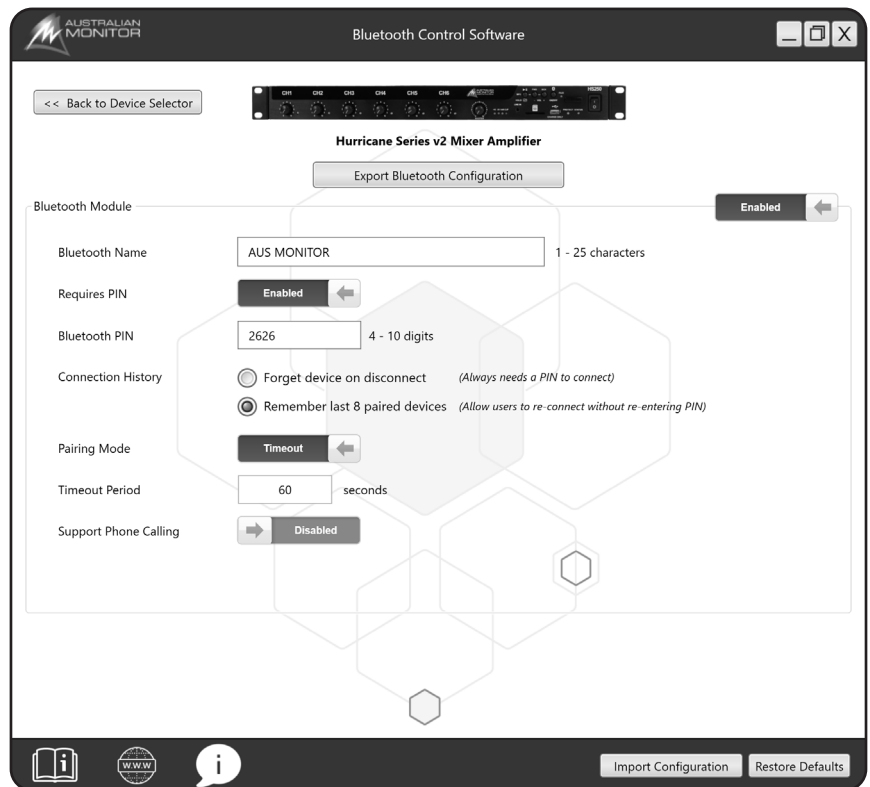

Bluetooth Control Software

# OPERATION CONT.

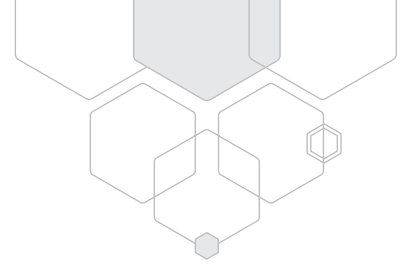

## VOLTAGE CONTROLLED ATTENUATION (VCA)/MASTER MUTE

The VCA input allows remote volume control of the mixer and muting of the master output.

**VCA Mode:** Connect an Australian Monitor RC1 remote panel or any 500kΩ logarithmic potentiometer between the VCA and GND terminals of the 10 way Phoenix block connector to adjust the volume.

**Master Mute Mode:** Short VCA to the GND pin.

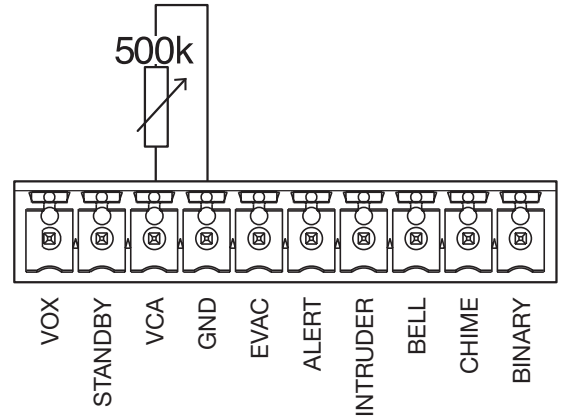

## VOX OUTPUT

The voice operated output (VOX) indicates when any of the priority input channels are triggered.

Connect the VOX and GND connection to any external control solution to read this signal.

The VOX output is an open collector output.

Maximum voltage relative to GND	35V
Maximum current	100mA

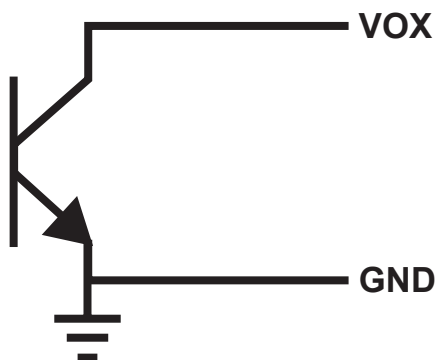

## STANDBY INPUT

The standby mode can be activated by connecting the STANDBY pin to the GND pin. The status LED will blink every 4 seconds to show the product is in standby mode.

While in standby mode the following will still be active:

### 1. EVAC, ALERT & INTRUDER tone trigger inputs

Triggering any of these inputs will cause the device to exit Standby Mode and play the Tone. When the tone trigger is released the mixer will re-enter standby mode immediately.

**⚠ NOTE:** The amplifier will take approx 5s to exit standby mode and play audio.

## USB CHARGING

The USB charging port is provided to charge mobile devices. It provides 500mA of charge current at 5V.

It does not support playing of audio through the USB port such as mass storage mode. Instead, stream audio from your mobile device to the HSMIX using the Bluetooth streaming feature.

**⚠ NOTE:** Some mobile devices require higher current requirements to charge, therefore the USB charger may only be able to slow the devices power consumption.

In addition, some phones/tablets require that the manufacturer's charger be used when charging the battery from flat. If your phone does not start charging from the USB port please use your device manufacturer's supplied charger.

# OPERATION CONT.

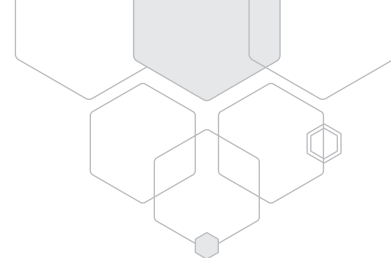

## SD CARD FORMAT

**Note:** Please consult the Australian Monitor website to download default tones and other test files for your SD card – [www.australianmonitor.com.au](http://www.australianmonitor.com.au)

### SD CARD SUPPORT

Maximum SD card capacity	2TB See <b>Support of SD cards larger than 32GB</b> section for further details
File Format System	FAT32. (NOTE: Do NOT use the exFAT format)
Maximum individual file size	4GB

**NOTE:** SD cards larger than 32GB are shipped by manufacturers with the exFAT file format. These cards must be re-formatted to FAT32 to operate with the mixer.

### SUPPORTED AUDIO FILE FORMATS

WAV	PCM, 8 or 16 bit, up to 48kHz sample rate
MP3	MPEG-1, MPEG-2 and MPEG-2.5, up to 48kHz 320kHz bitrate, CBR or VBR

**NOTE:** If you do not know the properties of your file use a third party application like AudioShell.

## TONE FILE/FOLDER STRUCTURE AND FORMAT

### OVERRIDING DEFAULT TONES

To override the inbuilt default tones, place an MP3 or WAV file on the root of the SD card with the tone name and optional volume setting in the filename.

File Format:	<b>Tonename _ Volume.mp3</b>	(Valid 'Tonenames' are evac, alert, intruder, bell or chime)
Examples:	evac.mp3	overrides the inbuilt EVAC tone with this file
	alert_75.wav	overrides the inbuilt ALERT tone with this file and set volume to 75

### USER DEFINED TONES

To add user defined tones, place an MP3 or WAV file on the root of the SD card. It must be named with the trigger number and optional track name, priority mode and volume setting in the filename.

File Format:	<b>Trigger Number _ Track Name _ mixN_Volume.mp3</b> The <b>only mandatory field is the Trigger number</b> . Track Name, Mixer Priority and Volume are optional. If a custom volume is being used you <b>MUST</b> enter a track name: 1_Mandatory Track name_75.mp3 ✓ 1_75.mp3 ✗ (Track name missing)	
Examples:	1.mp3	Trigger input 1 with no track name or custom volume
	3_Custom MP3 tone.mp3	Trigger input 3 with track name but no custom volume
	7_Track Name_60.wav	Trigger input 7 with track name and a custom volume of 60
	11_Track Name_mix1_75.mp3	Trigger input 11 with track name, priority set to Ch1 active all other muted, custom volume of 75

# OPERATION CONT.

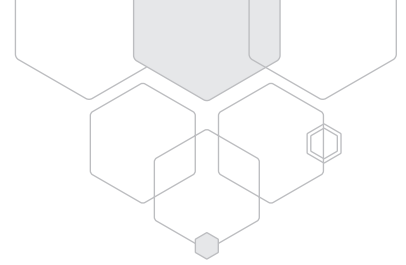

## SD CARD FORMAT CONT.

### USER DEFINED TONE PRIORITY OVERRIDE

**File Format:** Trigger Number \_ Track Name \_ mixN\_Volume.mp3

In order to activate the priority mode for an individual tone

(or to override the current priority mode setting), append the filename with the following to change the priority muting mode:

- ‘\_mix0’ in the filename will mute all channels. Channel priority selection is not honoured (disabled).
- ‘\_mix1’ in the filename will mute all channels except Ch1. Channel priority selection is not honoured (disabled).
- ‘\_mix3’ in the filename will mute all channels except Ch1 to Ch3. Channel priority selection is honoured (enabled) for Ch1 to Ch3.

### SEQUENCE FOLDER

In order to play a series of audio files in sequence,

1. Create a folder on the root of the SD card named ‘sequence’
2. Place MP3 or WAV files inside the ‘sequence’ folder and prefix them with required sequence number.

**! IMPORTANT:** The file must contain the prefix number or the file will not be played. In addition, the sequence must be continuous and contain no gaps in the track numbering. i.e. 1,2,3,5 would only play tracks 1-3 and then repeat.

**File Format:** Sequence Number \_ Track Name \_ Volume.mp3

### SEQUENCE FOLDER VOLUME

The sequence files volume can also be set globally by adding a volume.txt file **inside** the folder.

This provides an easier method than having to set each filename within the sequence folder.

1. Create a text file named ‘volume.txt’
2. Enter a value from 1 to 100 inside the text file.

**NOTE:** If a track has a volume specified in its track name this will supersede the folder volume setting in the volume.txt file

**Example:**

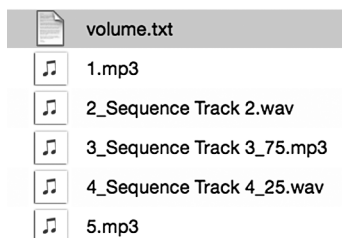

# OPERATION CONT.

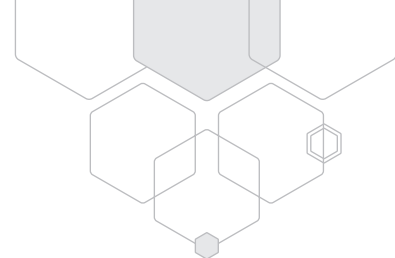

## SD CARD FORMAT CONT.

### RANDOM FOLDER

In order to play random audio files they must be placed in a 'random' folder of the SD card,

1. Create a folder on the root of the SD card named 'random'
2. Place any MP3 or WAV files inside the 'random' folder.  
The audio files do not need to follow a naming convention.

### RANDOM FOLDER VOLUME

The random files volume can also be set globally by adding a volume.txt file **inside** the folder.

This provides an easier method than having to set each track's volume individually.  
Refer to the 'Sequence Folder Volume' section for an example of how to apply this setting.

**NOTE:** If a track has a volume specified in its track name this will supersede the folder volume setting in the volume.txt file.

### SD CARD CONTENTS EXAMPLE

Folder/File Structure:

- ▶ sequence
- ▶ random
  - 🎵 1\_Track Name\_MixN\_Volume.mp3
  - 🎵 2\_Track Name\_MixN\_Volume.wav
  - 🎵 3\_Track Name\_MixN\_Volume.mp3
  - 🎵 4\_Track Name\_MixN\_Volume.wav
  - 🎵 5\_Track Name\_MixN\_Volume.mp3
  - 🎵 6\_Track Name\_MixN\_Volume.wav
  - 🎵 7\_Track Name\_MixN\_Volume.mp3
  - 🎵 8\_Track Name\_MixN\_Volume.wav
  - 🎵 9\_Track Name\_MixN\_Volume.mp3
  - 🎵 10\_Track Name\_MixN\_Volume.wav
  - 🎵 11\_Track Name\_MixN\_Volume.mp3
  - 🎵 alert\_Volume.mp3
  - 🎵 bell\_Volume.wav
  - 🎵 chime\_Volume.mp3
  - 🎵 evac\_Volume.wav
  - 🎵 intruder\_Volume.mp3

Example:

- ▶ sequence
- ▶ random
  - 🎵 1.mp3
  - 🎵 2.wav
  - 🎵 3\_Custom filename.mp3
  - 🎵 4\_Custom filename.wav
  - 🎵 5\_Custom filename with custom volume\_75.mp3
  - 🎵 6\_Custom filename tone with custom volume\_75.wav
  - 🎵 7\_Custom filename tone with priority\_mix1.mp3
  - 🎵 8\_Custom filename tone with priority and custom volume\_mix0\_75.wav
  - 🎵 9.wav
  - 🎵 10.mp3
  - 🎵 11.wav
  - 🎵 alert.mp3
  - 🎵 bell.wav
  - 🎵 chime\_50.mp3
  - 🎵 evac\_50.wav
  - 🎵 intruder.mp3

All files and folders are optional.

If the amplifier tries to read a file or folder selection that does not exist on the SD card it will flash an error on the STATUS LED.

### SUPPORT OF SD CARDS LARGER THAN 32GB

The HS series mixer amplifiers support the FAT32 file format which is limited to a maximum of 2TB.

However, SD cards larger than 32GB are shipped with the exFAT format. These must be reformatted to the FAT32 format.

**NOTE:** Windows does **NOT** natively support formatting of SD cards larger than 32GB to FAT32.

You must use third party applications to format SD cards larger than 32GB to the required FAT32 format.



# FAULT FINDING

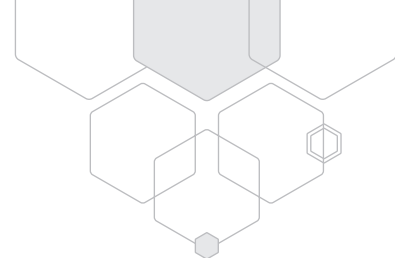

## STATUS INDICATOR

If the **blue STATUS LED** is flashing instead of remaining on it can indicate a possible fault.

See the table below on the meaning and how to resolve the fault.

FLASHES	MEANING	CAUSE	RESOLUTION
1	SD card absent or faulty	The front panel Music player buttons or 10way Phoenix connector has requested a file to be played but the mixer cannot read the SD card.	<ul style="list-style-type: none"><li>• Insert an SD card</li><li>• Check the SD card is correctly formatted to FAT32</li><li>• Power cycle the unit to clear the fault if no SD card is being used</li></ul>
2	SD card folder error	The mixer is trying to access a folder on the SD card that does not exist or is named incorrectly	Check the SD card folder is present and named correctly
3	SD card file error	The mixer is trying to access a file on the SD card that does not exist or is named incorrectly	Check the file on the SD card file is present, named correctly and is a supported file format See <b>SD card format section</b>
4	NOR flash image failure*	NOR flash image failure*	Please return mixer to your nearest service centre*
5	NOR flash read/write failure*	NOR flash read/write failure*	Please return mixer to your nearest service centre*
6	AMP initialisation error*	AMP initialisation error*	Please return mixer to your nearest service centre*
7	MP3 hardware failure*	MP3 hardware failure*	Please return mixer to your nearest service centre*

\* Failures 4-7 should be referred to your local service department as these cannot be resolved by the end user.

# FAULT FINDING

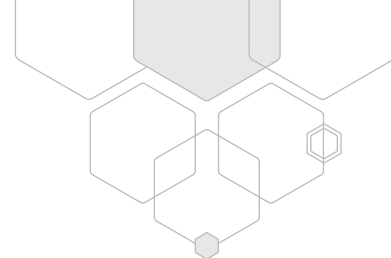

## PROTECT INDICATOR

The following table indicates the meaning of each protection mode,

LED	MEANING	RESOLUTION
Yellow flashing	Amplifier temperature warm	None required
Yellow on	Amplifier temperature hot	None required
Red flashing	Amplifier over temperature	The amplifier has shutdown. It will automatically restart once it has cooled down
Red on (Status LED on)	Amplifier protect	Check the speakers connected to the amplifier are corrected wired. Power cycle the unit and retry.
Red/Yellow flashing	USB power fault	A mobile device has attempted to draw too much current. Please remove the device from the amplifier USB port
Red on (Status LED off)	Amplifier in Service Mode	Turn OFF the back panel 'S' switch and power cycle the unit to enter normal operation.

## MAINTENANCE

Only competent or qualified persons should attempt any service or maintenance of your amplifier. Your HS Series amplifier will need minimal maintenance. No internal adjustments need to be made to the unit to maintain optimum performance. To provide years of unhindered operation we suggest a maintenance inspection be carried out annually by a qualified technician.

## FIRE REGULATION COMPLIANCE

This amplifier is not certified to fire regulations standards such as EN 54-16.

# SPECIFICATIONS

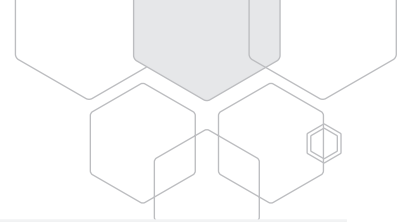

MODEL	HS120v2	HS250v2	CONDITIONS/COMMENTS
TOPOLOGY	Class-D	Class-D	
CHANNELS	1	1	
POWER OUTPUT (PER CHANNEL)			
4Ω	120W	250W	1kHz. 1%THD. -10W/+30W
70V	120W	250W	1kHz. 1%THD. -10W/+30W
100V	120W	250W	1kHz. 1%THD. -10W/+30W
MAXIMUM OUTPUT LEVEL	29dBu (21.9Vrms )	32dBu (31.6Vrms )	20Hz - 20kHz, <1%THD, 4Ω
SYSTEM GAIN	29dB	32dB	Gain and Volumes controls at mid position
FREQUENCY RESPONSE 4Ω	20Hz - 20kHz		3dB below clipping, +0/-3dB.±5Hz
FREQUENCY RESPONSE 100V	100Hz - 16kHz		3dB below clipping, +0/-3dB.±5Hz Low Frequency ±2kHz High Frequency
SIGNAL TO NOISE RATIO	> 75 dBr		Max Output, 1kHz, 20kHz BW, A-Weighted
THD+N. 4Ω, 8Ω. 1kHz	< 0.2%		3dB below clipping, 1kHz. 20kHz BW, Unity Gain, A-Weighted
THD+N. 4Ω, 8Ω. 20Hz - 20kHz	< 0.3%		3dB below clipping, 20Hz - 20kHz. 20kHz BW, Unity Gain, A-Weighted
THD+N. 100V. 1kHz	< 0.3%		3dB below clipping, 1kHz. 20kHz BW, Unity Gain, A-Weighted
THD+N. 100V. 20Hz - 20kHz	< 0.3%		3dB below clipping, 20Hz - 20kHz. 20kHz BW, Unity Gain
DAMPING FACTOR	> 90		20Hz - 1kHz, 8Ω. ±10
DC INPUT OFFSET	< 30 mV		
<b>AUDIO INPUT/OUTPUTS</b>			
INPUT CONNECTORS	3 XLR/RCA Inputs with MIC/LINE level control 3 Phoenix/RCA Inputs with MIC/LINE level control 3.5mm front panel audio jack		
INTERNAL AUDIO INPUTS	Bluetooth Audio Input, MP3 Player Input		
PRE-AMPLIFIER OUTPUTS	Record Output (Pre-Master), Line Output (Post-Master)		
SPEAKER OUTPUT	6 pin Screw Terminal		
<b>SENSITIVITY</b>			
XLR INPUT SENSITIVITY	LINE Setting: 0.775V MIC Setting: -45dBu(4.355mV)		Equaliser and Gain set to mid position. Volume to maximum
RCA INPUT SENSITIVITY	-12dBu (200mV)		Equaliser and Gain set to mid position. Volume to maximum
LINE IN TO MAX OUTPUT	400mV (-5.75dBu)		Master volume set to maximum
RECORD OUT	-12dBu (200mV)		Input channel and Master volume set to maximum. 10kΩ termination
LINE OUT	0dBu (0.775V)		Input channel and Master volume set to maximum. 1kΩ balanced termination
GAIN/TRIM	±12dB		
CHANNEL EQUALISER	100Hz ±12dB, 10kHz ±12dB		
MASTER EQUALISER	100Hz ±12dB, 1600Hz ±12dB, 10kHz ±12dB		
<b>BLUETOOTH</b>			
VERSION	Bluetooth 5.1 supporting A2DP, AVRCP and HFP profiles		
RANGE	10m range		Note: Range is typically much larger but not guaranteed

# SPECIFICATIONS



<b>ADDITIONAL FEATURES</b>			
PHANTOM POWER	12V, 15mA maximum per channel		
	35V, 100mA Maximum		
VCA	500kΩ Logarithmic Potentiometer Input		
TONE GENERATOR	5 default tones + 11 user customisable tones		
MUSIC PLAYER	Embedded WAV/MP3 player		
SUPPORTED MODES	Individual track, sequence folder, random folder, play 1 random, play 1 sequence		
SUPPORTED FILE FORMATS	MP3: MPEG-1, MPEG-2 and MPEG-2.5, up to 48kHz 320kHz bitrate, CBR or VBR. WAV: PCM, 8 or 16 bit, up to 48kHz sample rate.		
SD CARD	Full size SD card. FAT32 file format. 2TB maximum size		
USB	USB charge only port. 5V, 500mA		
<b>MISCELLANEOUS</b>			
INPUT CMRR	> 55dB		20Hz - 20kHz
LED STATUS	Channel - Green/Red Master - 4 level meter Protect - Yellow/Red Status - Blue Bluetooth - Blue		
USER CONTROLS	<ul style="list-style-type: none"> <li>• Channel Gain/Trim, Bass, Treble, Volume</li> <li>• Master Gain/Trim, Bass, Mid, Treble, Volume</li> <li>• Channel phantom power, line/MIC input selector                             <ul style="list-style-type: none"> <li>• Priority selection and control</li> </ul> </li> <li>• 10 way euro connector - VCA, Standby, VOX, Tone generator</li> </ul>		
OVERLOAD PROTECTION	Temperature, Over Voltage, Current Limit		
<b>POWER REQUIREMENTS</b>			
AC INPUT	220-240Vac, 50-60Hz	100-240Vac, 50-60Hz	±10%
AC POWER FACTOR	>0.64	>0.95	Max Output, 1kHz, 230Vac
AC INPUT CONNECTOR	IEC 60320-C14		
AC MAINS FUSE	T3.15AL 250V	T5AL 250V	264VAC, 53Hz
MAXIMUM INRUSH CURRENT	24A	28A	264VAC, 50Hz
<b>RMS CURRENT DRAW</b>			
STANDBY	0.067A	0.128A	230Vac, 50Hz, 100V Output
IDLE	0.113A	0.154A	230Vac, 50Hz, 100V Output
1/8 POWER	0.250A	0.327A	230Vac, 50Hz, 100V Output
1/3 POWER	0.486A	0.627A	230Vac, 50Hz, 100V Output
FULL POWER	1.25A	1.5	230Vac, 50Hz, 100V Output HS120v2=110W, HS250v2=220W
<b>POWER CONSUMPTION</b>			
STANDBY	3.50W	12.00W	230Vac, 50Hz, 100V Output
IDLE	12W	20W	230Vac, 50Hz, 100V Output
1/8 POWER	33W	61W	230Vac, 50Hz, 100V Output
1/3 POWER	73W	139W	230Vac, 50Hz, 100V Output
FULL POWER	182W	337W	230Vac, 50Hz, 100V Output HS120v2=110W, HS250v2=220W

# SPECIFICATIONS CONT.

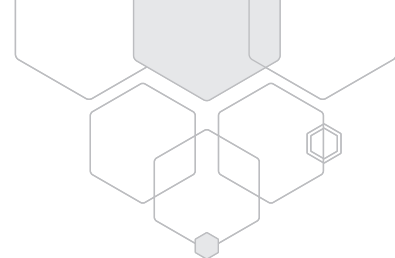

<b>POWER REQUIREMENTS CONTINUED</b>			
<b>EFFICIENCY</b>			
1/8 POWER	41%	47%	230Vac, 50Hz, 100V Output
1/3 POWER	55%	60%	230Vac, 50Hz, 100V Output
FULL POWER	60%	65%	230Vac, 50Hz, 100V Output HS60=55W, HS120=110W, HS250=220W
<b>THERMAL DISSIPATION</b>			
STANDBY	12	41	Excludes Load Power (1W = 3.412BTU/Hr)
IDLE	42	68	Excludes Load Power (1W = 3.412BTU/Hr)
1/8 POWER	124	226	Excludes Load Power (1W = 3.412BTU/Hr)
1/3 POWER	250	474	Excludes Load Power (1W = 3.412BTU/Hr)
FULL POWER	622	1150	Excludes Load Power (1W = 3.412BTU/Hr)
PRODUCT DIMENSIONS (WITH RACK EARS) W X D X H	483 x 306 x 44mm (19 x 12.05 x 1.73")	483 x 406 x 44mm (19 x 16 x 1.73")	
PRODUCT DIMENSIONS (WITHOUT RACK EARS) W X D X H	438 x 306 x 44mm (17.24" x 12.05" x 1.73")	438 x 406 x 44mm (17.24" x 16" x 1.73")	
SHIPPING DIMENSIONS W X D X H	510 x 415 x 100mm (20.1 x 16.3 x 3.9")	510 x 510 x 100mm (20.1 x 20.1 x 3.9")	
NET WEIGHT	5.3 Kg (11.68 lbs)	6.8 Kg (15 lbs)	
SHIPPING WEIGHT	6.6Kg (14.6 lbs)	8.3Kg (18.3 lbs)	
MOUNTING	1 RU		
OPERATING TEMPERATURE	0°C to 40°C (95% RH)		
COOLING SYSTEM	Convection cooled	Fan assisted convection cooling	
FAN NOISE	Not Applicable	60dBA	Noise measured at 20cm from fan intake
FINISH (ALL MODELS)	Powder coated steel/ALU front panel		
COLOUR (ALL MODELS)	Black		
ACCESSORIES (ALL MODELS)	IEC Mains cable. Rubber Feet x 4, Four 1x3 terminal socket, One 1x10 terminal socket, Rack mount support		
APPROVALS	CE, IEC, RCM		

# SERVICE INSTRUCTIONS

## – FOR SERVICE PERSONNEL ONLY

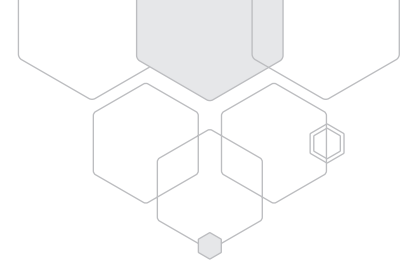

### BASIC UPDATE PROCEDURE:

1. Insert an SD card into a PC (see owners manual for compatible SD cards)
2. Navigate to <https://www.australianmonitor.com.au/collections/mixeramplifiers/products/hs120v2> and then click on the download tab
3. Download Firmware Update
4. Navigate to the downloads folder and unzip the downloaded firmware
5. Copy the flash directory that contains the new firmware binary to the root of the SD card (shown below)

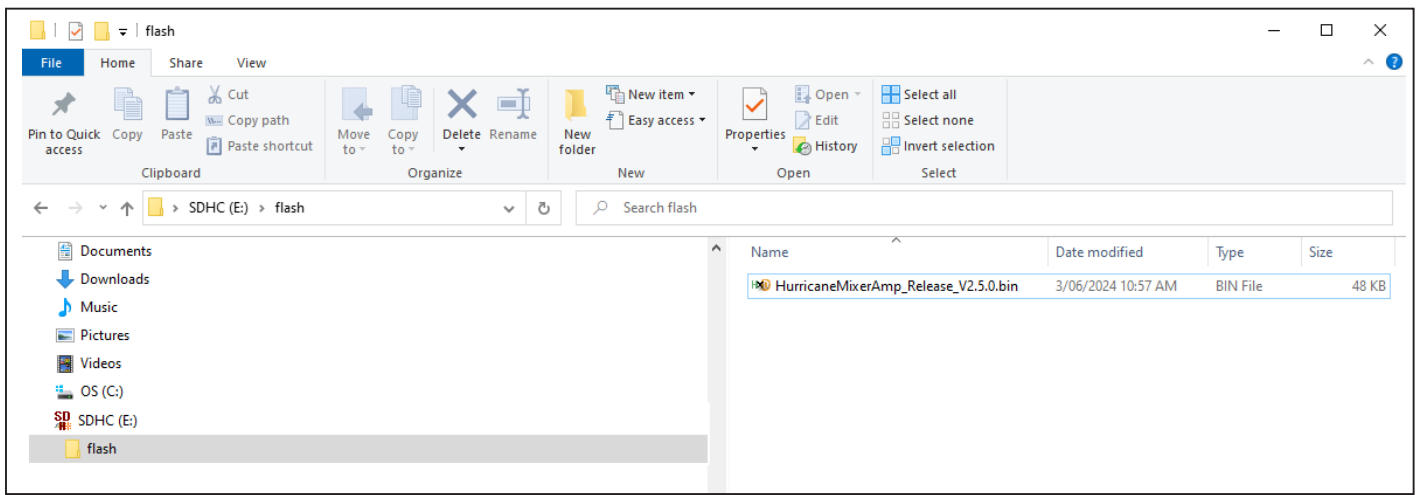

6. Turn the power off to the HS product and then insert the SD card into the front of the unit
7. Turn the power back on. The status LED will blinky quickly to indicate the new firmware versionis being copied over
8. Once the firmware update is complete the status LED will remain solid on to indicate normal operation

### FINAL CHECK TO DISPLAY FIRMWARE VERSION

To show the current firmware version, Hold the “FWD” and “BCK” buttons down simultaneously. A combination of flashes from the PROTECT and STATUS LEDs show the firmware version.

PROTECT LED = Major firmware version

STATUS LED = Minor firmware version.

Example: If the firmware was updated to V2.5 then the PROTECT LED would flash twice and the STATUS LED would flash five times to indicate V2.5

### SPARE PARTS

PART NUMBER	DESCRIPTION	APPLICATION
PC-381-3	3way 3.81mm pitch connector	Used for the channels 4-6 audio inputs
PC-381-10	10way 3.81mm pitch connector	Used for the logic input connector
HS-COVER	Magnetic acrylic cover	Replacement front panel concealment cover
TXKNOB	Volume control knob	Replacement volume control knob





**ENGINEERED BY AUSTRALIAN MONITOR**

Address: Unit 1, 2 Daydream Street, Warriewood NSW 2102 Australia

Website: [www.australianmonitor.com.au](http://www.australianmonitor.com.au)

International enquiries email: [international@australianmonitor.com.au](mailto:international@australianmonitor.com.au)

ABN 86 003 231 187